

**433

*157

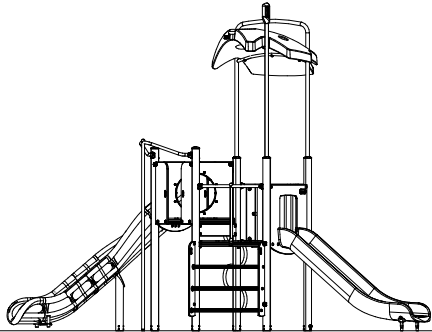

PCE211402
1:100